

TRT800H - OLED Mode S Transponder



P/N 800ATC-H-(201)-(201)

Operation and Installation

(Document-No. 03.2123.010.71e)

Change History

Revision	Date	Description of Change
1.00	19.11.2008	First Release
1.01	05.03.2009	Added explanation of „LOCK“ indicator in 2.3 In consequence of customer feedback added hint in section 4.2.1.
1.02	24.04.2009	Corrections after internal review
1.03	02.07.2010	Corrections after internal review Added information on connectors
1.04	24.01.2011	Extended function with interface RS232 starting from SW5.2
1.05	30.03.2011	Corrections after internal review 2.6 StBy-Function

List of Service-Bulletins (SB)

Service Bulletins have to be inserted into this manual and to be enlisted in the following table.

SB No	Rev. No.	Issue Date	Insertion Date	Name
SB TRT800-A-H-1	1.04	17.10.2008		

Survey of Variants

Part Number	Description
P/N 800ATC-H-(201)-(201)	Version with OLED-Display / one VFR-Code / eight storable record sets for AA-/AC-Code (ICAO 24bit-Address), FID, Ground-Switch, RI-Code, GPS-/Interface-Setting

Table of Contents



1	GENERAL	5
1.1	Symbols	5
1.2	Abbreviations	6
1.3	Customer Support	7
1.4	Features	8
2	OPERATION	9
2.1	Controls	9
2.2	ON/OFF	11
2.3	Display-Brightness	11
2.4	Display-Indications	11
2.5	Flight-ID (FID)	13
2.5.1	Display Flight-ID	13
2.5.2	Configure Flight-ID	13
2.6	Transponder Mode selection	14
2.7	Squawk-Setting	14
2.8	VFR – Squawk	15
2.9	ID – Special Position Identification (SPI): “Squawk Ident”	15
2.10	Error-Codes	15
3	INSTALLATION	16
3.1	Notes	16
3.2	Telecommunication data	16
3.3	Scope of Delivery	16
3.4	Unpacking and Inspecting of the Equipment	17
3.5	Mounting	17
3.6	Equipment Connections	18
3.6.1	Electrical Connections	18
3.6.2	Static Air Port	19
3.7	Wiring	20
3.7.1	Conductor Cross Section	20
3.7.2	TRT800EM – External Memory	20
3.7.3	TRT800EMSS – External Memory (with RS232)	21
3.8	Antenna	22
3.8.1	Antenna Selection	22

3.8.2	Installation Recommendation	22
3.8.3	Antenna Wiring	23
3.9	Post-Installation Check	23
3.10	Starting Up	24
3.11	Accessories	24
3.12	Drawings	25
3.12.1	Dimensions	25
3.12.2	Mounting Advices	25
4	SETTINGS	26
4.1	Overview	26
4.1.1	Error Logging	26
4.1.2	ICAO 24-Bit Aircraft Address (AA)	26
4.1.3	Aircraft Category (AC)	27
4.1.4	Flight-ID (FID)	27
4.1.5	Option Ground-Switch	28
4.1.6	Reply Information - Speed Category (RI)	28
4.1.7	Serial Interface (RS232)	29
4.2	Configuration	31
4.2.1	Setup Steps	31
4.2.2	Functions Overview	34
5	APPENDIX	36
5.1	Technical Data	36
5.2	Environmental Conditions	38

1 GENERAL

This manual contains information about the physical, mechanical and electrical characteristics and about installation and operation of the Mode S Transponder TRT800H.

1.1 Symbols

	Advices whose non-observance can cause radiation damage to the human body or ignition of combustible materials
	Advices whose non-observance can cause damage to the device or other parts of the equipment.
	Supplementary information

1.2 Abbreviations

Abb.	Meaning	Explanation
FID	Flight ID	Flight plan number or if not assigned registration number of aircraft
SPI	Special Position Identification	Activation on request by controllers „Squawk Ident“, transmits SPI Pulse for 18 seconds, which highlights the respective traffic item on the controllers radar screen
AA	Aircraft Address	assigned ICAO 24 bit Address
AC	Aircraft Category	Defines aircraft type into specific categories
RI	Reply Information	Maximum airspeed

1.3 Customer Support

In order to facilitate a rapid handling of return shipments, please follow the instructions of the input guide „Reshipment RMA“ provided at the **Service**-Area within the Funkwerk Avionics web portal www.funkwerk-avionics.com.



Any suggestions for improvement of our manuals are welcome. Contact: service@funkwerk-avionics.com.



Informations on software updates are available at Funkwerk Avionics

1.4 Features









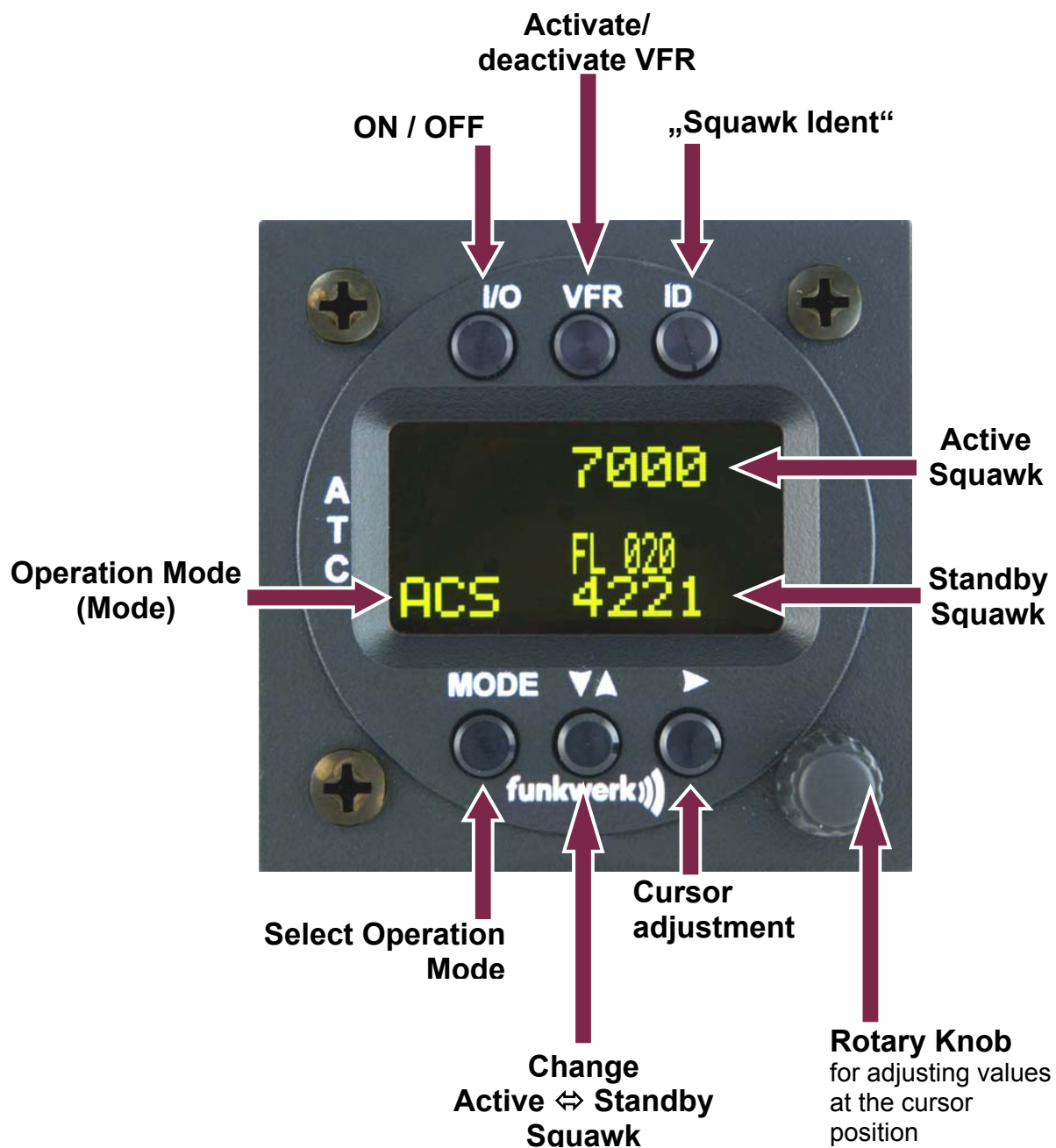

In order to operate the Mode-S transponder it is necessary to request an ICAO 24-Bit Aircraft Address at the responsible national aviation authorities. The received Code is assigned to the specific transponder/aircraft and must be configured within the transponder. The 24bit Address is stored in an external memory which allows the transponder being exchanged without requiring any further configuration. (for detailed information refer to sections 4.1.2 and 4.2.1).

- Class 1 Level 2es Non-Diversity Mode-S-Transponder for ground based interrogations at 1030 MHz and response at 1090 MHz
- Replies to (Secondary) Radar Interrogations
 - Mode-A replies with a Squawk (one of 4096 possible Codes; e.g. flight plan number, Squawk assigned by a Controller or the VFR Squawk 7000)
 - Mode C replies, including encoded flight level
 - Mode S replies, including aircraft address and flight level
 - Extended Squitter, containing additional information on position and velocity
- IDENT capability for activating the Special Position Identification“-Pulse (SPI) for 18 seconds, which is requested by the Controller „Squawk Ident“
- Maximum flight level 35 000 ft; maximum airspeed 250 kt
- Display information contains Squawk code, mode of operation and pressure altitude.
- Temperature compensated high precision piezo-resistive pressure sensor
- RS-232 I/O data port enabling connection with certain GPS- Receivers in order to support ADS-B Out
- 8 storable entries for AA-/AC-Code, FID, Ground-Switch, RI-Code and GPS-/Interface-setting (stored in external memory TRT800EM)

2 OPERATION

2.1 Controls



	ON/OFF	Switch ON press button for approx. 0,5 s Switch OFF press button for approx. 3 s
	VFR	1. activate/deactivate VFR Squawk (press shortly) 2. store active Squawk as VFR/VFRW-Squawk (press button 3 s) see section. 2.8
	CHANGE	1. change between active and standby-Squawk 2. works as cursor back button (opposite function of the cursor button) during entering values and also for navigating backwards through the configuration menu (see 4.2.1)
	IDENT	1. „Squawk Ident“, sends Ident marking (SPI) for 18 s (in normal mode) see section. 2.9 2. configuration of Flight-ID (FID) (in standby mode, press button for 5 s)
	MODE	Select transponder mode ACS, A-S or Standby (see section 2.6)
	CURSOR	Set position of Cursor
	Rotary Knob	Adjust/Enter values at current cursor position, select options; set standby Squawk see section 2.7

2.2 ON/OFF

Switch ON:  press button for 0.5 s

Switch OFF:  press button for 3 s

After turning-on the display appears as follows:



Device Name

Software-Version

Firmware-Version

(Example)

If more than one aircraft address/FID exists, select the correct entry with the rotary knob and confirm with **MODE**. If there is no external memory (TRT800EM) connected or no 24bit address defined (000000) the message "CRADLE OFF" appears and the transponder is not working as Mode-S device but as Mode A-C transponder.

The transponder starts in standby mode (see section 2.6).

2.3 Display-Brightness



In active mode (not standby) press  -button for 2 s

Display indicates "DIM" → Adjust brightness (DIM) with rotary knob

Return to normal operation: press  or wait 5 s.

2.4 Display-Indications



Value	Meaning	Remarks
 diamond	Transponder is transmitting: Replies on Interrogations Extended Squitter (ADS-B out)	Appears per reply
7000	active Squawk	
I	Transponder is locked by a ground station and will be directly addressed	Lock Information (indicated as vertical dash below the diamond)
PLL	PLL Error	Internal Error
TRX	Transmit Failure	
DC	Low internal voltage	Internal error
FPG	FPGA-Failure	Internal error
BAT	Battery Power too low	maybe battery/generator fault
IDT	transmits Ident-Marking (SPI)	ID („Squawk Ident“) has been pressed – active for 18 s
FL010	Flight Level	Flight Level (in 100 ft steps)
FLerr	Invalid altitude measuring	Beyond -1000 ... 35 000 ft, C Mode gets inactive
ACS	Operational Mode (STBY, A-S, ACS, AC, A)	Modes see section 2.6
0000	Standby Squawk	Could be changed with active Squawk by pressing 
F	in-flight	Ground-Switch-Info (if installed/available)
G	on-ground	
Cradle Off	no AA (24bit-Address) configured	Transponder works in A/C-Mode (no Mode-S)

2.5 Flight-ID (FID)

The FID is an identifier required by Mode-S Operation. During future application of flight plans a FID could be assigned on a per flight basis. If no FID is assigned (today's normal case) the registration marking of the aircraft should be used as FID. The FID should not contain dashes or blanks. The FID must not be confused with the 24-bit Aircraft Address.

2.5.1 Display Flight-ID

Press **MODE** (repeatedly) until „STBY“ appears

Press and hold **D**; while a counter is shown beside the active squawk, release **D** at values between 1 and 4

Display:

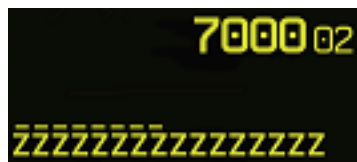

The lower line contains the 24bit address (AA) and the aircraft category (AC), marked by a line above the numbers as well as the Flight-ID (FID) without any line above the numbers (“^”=cursor):

- Digits 1 to 6: ICAO 24-bit Aircraft Address (AA, HEX-format)
- Digits 7 to 8: Aircraft Category (AC)
- Digits 9 to 16: Flight Identification (FID)

This screen will appear for 5s and will be left automatically afterwards.

2.5.2 Configure Flight-ID

Press **MODE** (repeatedly) until „STBY“ appears

Press and hold **D**; while a counter is shown beside the active squawk, release **D** at values between 5 and 19

Enter Flight-Id with cursor button  and rotary knob



Enter FID left-aligned, without any blanks or dashes (!), e.g. 12345621DEFAV for the marking D-EFAV. The last remaining digits shall be filled with blanks

Press **MODE** to save and return to STBY

Please refer to section 4.2.1 for configuration of the 24-bit Address (AA) and Aircraft Category (AC).

2.6 Transponder Mode selection

Press **MODE** (repeatedly) to select from following Modes:

- **STBY** → „Standby“
Transponder does not respond to any interrogation. Squitter and ADS-B output is not active.
- **ACS** → „Mode A+C+S“
Standard condition; transponder responds to mode A, C and S interrogations.
- **A-S** → „Mode A+S, no C“
Altitude is not transmitted (neither on C nor on S requests). All other Mode-S data as well as Mode-A replies are transmitted.



If no 24-bit address (AA) was defined or entered as “000000” the transponder works as Mode A-C transponder, in that case the following Modes are possible apart from Standby:

- **AC-** → „Mode A+C“
Transponder replies only on Mode A and Mode-C interrogations.
- **A--** → „Mode A“
Transponder replies only on Mode A interrogations.

2.7 Squawk-Setting

The active Squawk is displayed in the upper line, while the standby Squawk is presented at the lower line.

Setting the Standby Squawk:

- Press  to set the cursor („^“), turn rotary knob to set numbers of the standby Squawk.
- Press  to activate the Standby Squawk , this moves the current active Squawk into Standby

2.8 VFR – Squawk

The transponder features a user-defined squawk code for VFR-flight (factory setting: 7000):

- Activate VFR-Squawk: Press **VFR** („VFR“ is indicated), now the active Squawk is moved into Standby but not visible because the indication of the Standby Squawk is overlapped by „VFR“
- Display Standby Squawk:
Press **VFR** or **▼▲** or use the  rotary knob (the VFR-Squawk remains active!)

Example:



- Now the Standby Squawk can be adjusted by using the  rotary knob and activated with **▼▲**.
- In order to store the current active Squawk as new VFR-Squawk (replacing the factory setting 7000):
Press and hold **VFR** until an „S“ is indicated (approx. 3 s); after releasing the button „VFR“ is shown

2.9 ID – Special Position Identification (SPI): “Squawk Ident”

Press ID to activate transmission of the special position identification pulse with every reply within 18 seconds; “IDT” appears on the display

By pressing **ID** a special position identification pulse (SPI) is transmitted with every reply within 18 seconds, which causes an accented marking on the Controller’s screen. The „Special Position Identification“ has to be activated after the „Squawk Ident“ request of the Controller.

2.10 Error-Codes

Please refer to 2.4 Display-Indications for possible displayed errors.

3 INSTALLATION

3.1 Notes

The following suggestions should be considered before installing.

The assigned installation company will supply wiring. For diagrams refer to 3.7 Wiring.

Transponder, External Memory, all cables and antennas shall be installed according to „*FAA AC-143.13-2A Acceptable Methods, Techniques and Practices – Aircraft Alterations*“ and the appropriate manufacturer’s instructions.

3.2 Telecommunication data

Depending on your national telecommunications legislation, the following data may be required when applying for the aircraft radio station license:

Manufacturer:	Funkwerk Avionics GmbH
Type Designation:	TRT800H
EASA Number:	EASA.210.269
Transmitter Power Output	126 W
Frequency:	1090 MHz
Emission Designator:	12M0M1D

3.3 Scope of Delivery

Part Number	Description
TRT800H	Transponder TRT800H
TRT800EM	External Memory (AC-Address-Adaptor with wiring)
M4X8ZSW (3 pieces)	screw for panels up to 5 mm thickness
56S101A4	TNC antenna connector
03.2123.010.71e	Manual „Operation and Installation“
	EASA Form 1

3.4 Unpacking and Inspecting of the Equipment

Carefully unpack the equipment and inspect for transport damages. If a damage claim has to be filed, save the shipping container and all packing materials as evidence to your claim.

	For storage or reshipment the original packaging should be used.
---	--

3.5 Mounting

- In cooperation with a maintenance shop, location and kind of the installation are specified. The maintenance shop can supply all cables. Suitable sets of cables are available from Funkwerk Avionics GmbH.
- Select a position away from heat sources. Care for adequate convection cooling.
- Leave sufficient space for the installation of cables and connectors.
- Avoid sharp bends and wiring close to control cables.
- Leave sufficient lead length for inspection or repair of the wiring of the connector (containing the memory), so that when the mounting hardware for the rear connectors is removed, the assembly may be pulled forward several inches.
- Bend the harness at the rear connectors to inhibit water droplets (formed due to condensation) from collecting in the connector.
- For mounting details/drawing refer to chapter 3.12.2 Mounting Advices.

3.6 Equipment Connections

3.6.1 Electrical Connections

One 15 pin D-SUB miniature connector includes all electrical connections, except for the antenna. Use only an External Memory Adapter TRT800EM or TRT800EMSS as they are part of the certification and include a memory with the stored ICAO 24bit Aircraft Address.



The (+UB)-wire has to be protected by a circuit breaker (2 Amp.)!

3.6.1.1 Mutual Suppression

Other equipment on board (e. g. DME) may transmit in the same frequency band as the transponder.

If such a device is installed a suppression wiring shall be installed in order to protect the receiving parts of the different devices from in-band transmissions.

Mutual suppression is a synchronous pulse that is sent to the other equipment to suppress transmission of a competing transmitter for the duration of the pulse train transmission. The transponder transmission may be suppressed by an external source and vice versa.

To activate mutual suppression connect the SUPP_I/O signal to the according signals of the other equipment

3.6.1.2 Ground Switch

If a Ground-Switch is connected (and activated in the Setup), the transponder is enabled to distinguish between On-Ground and In-Flight Condition. In On-Ground Condition the transponder automatically enters the Standby mode.

In order to activate this function the input „FLY-GND“ must be connected to a switch, which connects the input with „GND“ in case the gear is weighted, or remains open in the other case.

This option must additionally be activated in the Setup. For details on configuration please refer to section 4.2.1.

3.6.2 Static Air Port

Install a silicon soft tube fitting the 5 mm static air port at the backside of the transponder and secure plumbing with appropriate clamps.

3.7 Wiring

3.7.1 Conductor Cross Section

Power Supply (Power, GND): AWG20 (0,62 mm²)

Signals: AWG22 (0,38 mm²)

The conductors must be approved for aircraft use.

3.7.2 TRT800EM – External Memory

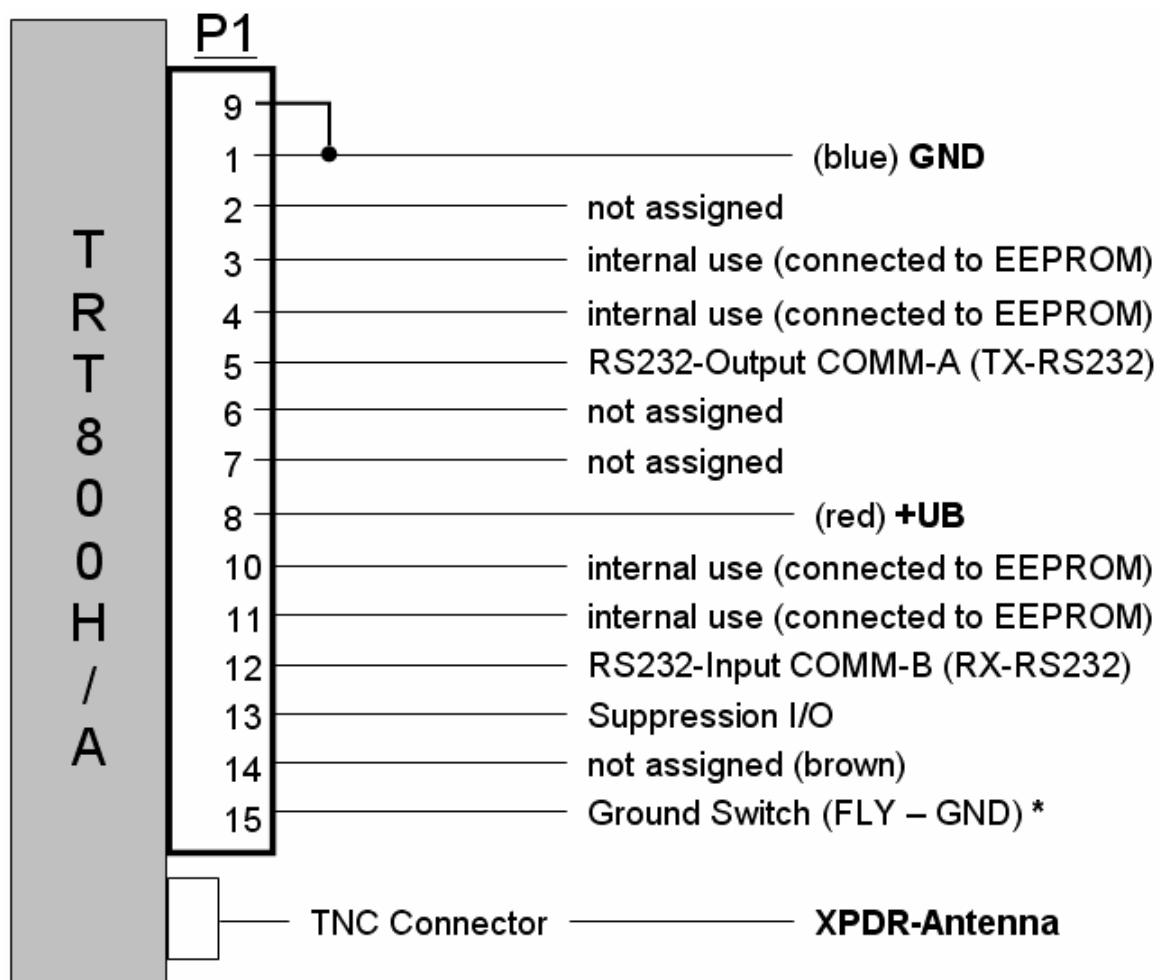

*	Ground Switch/ FLY-GND	If a ground switch is connected, in “on-ground” state pin 15 must be connected to „ GND“, otherwise leave Pin 15 open.
---	---------------------------	--

3.7.3 TRT800EMSS – External Memory (with RS232)

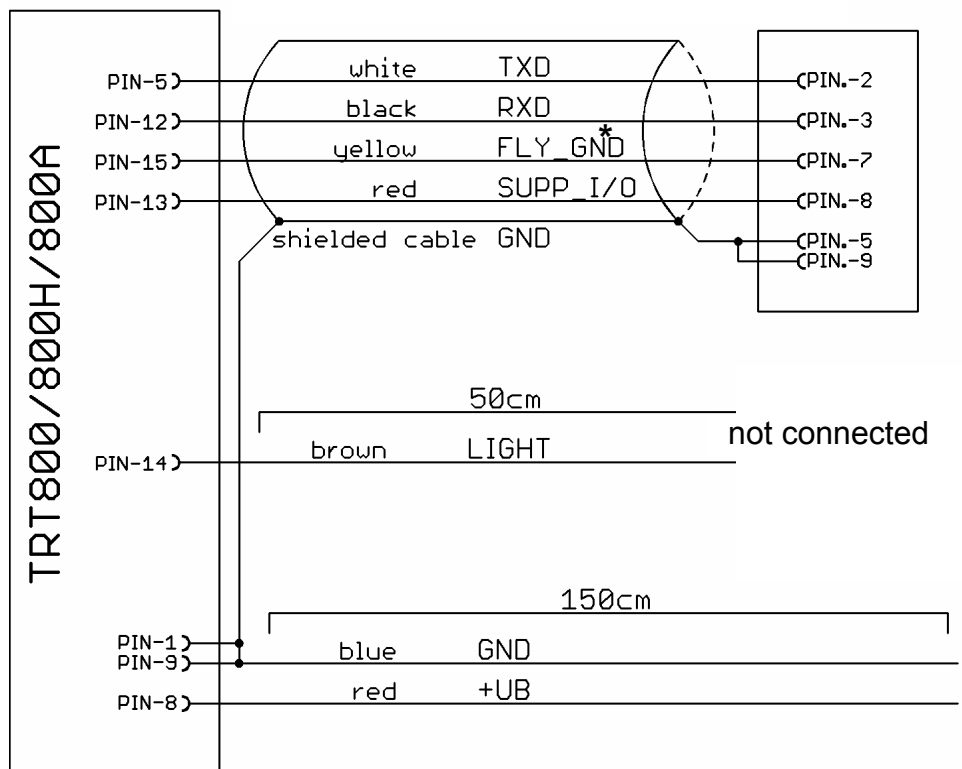

*	Ground Switch/ FLY-GND	If a ground switch is connected, in “on-ground” state pin 15 must be connected to „GND“, otherwise leave Pin 15 open.
---	---------------------------	---

3.8 Antenna

3.8.1 Antenna Selection

- Recommended antennas: see section 3.11 Accessories
- Choose an antenna type compatible with the vehicle and the mounting location.
- Specified features depend on proper installation of the antenna.
- The radiation pattern needs to be verified considering aircraft type and mounting location.
- The electrical interference between the antenna and any other equipment must be taken into account in such a way that no reduction of the performance of any other system will occur.
- Install only certified antennas!

3.8.2 Installation Recommendation

- Take note of the antenna manufacturer's instructions.
- The usually deployed Dipole- or Blade antennas necessarily require a high frequency capable solid metal ground plane at the antenna base.
- For installation in composite aircrafts, ground planes are to be added. The ground plane should be as large as possible but in any case not smaller than 10 cm x 10 cm. If in doubt, please contact the aircraft manufacturer.
- Keep away three feet from any other antenna.
- Pursue mounting in vertical position under the belly in flight direction.

3.8.3 Antenna Wiring

- Suitable antenna cables: see section 3.11 Accessories
- Keep wiring as short as possible.
- The smallest cable bend radius is 10cm. Avoid sharp bends.
- Keep away from an ADF antenna cable at least 12 inches.
- Electrical connections to the antenna shall be protected against moisture to avoid loss of efficiency.



Attenuation from antenna to transponder at 1090 MHz must not exceed 1.5 dB!

3.9 Post-Installation Check



A certified maintenance shop must verify proper operation of the transponder by testing in accordance with *Appendix F of "14 CFR Part 43 – ATC Transponder Tests and Inspections"*.

All steering and control functions of the aircraft are to be examined, in order to exclude disturbances by the wiring.



The most important factor in the transponder configuration is the setting of the ICAO address (see section 4.2.1).

3.10 Starting Up

Turn the transponder on with **I/O**.

After start-up the following screens appear:



	<p>The TRT800H starts in Standby Mode (indicated with STBY). In order to change into operational mode (indicated with ACS) press MODE.</p>
	<p>Very important is the correct configuration of the 24bit Aircraft-Address (see 4.2.1 Setup Steps).</p>

3.11 Accessories

Part Number	Description
TRT800EMSS	External memory (AC-Address-Adapter) for RS232 including wiring, 9-pol. SUB-D-Jack and Connector
TRKABEL2	Antenna cable 2,5 m (8.2 ft) TNC → BNC, RG-142, 1,075 dB
TRKABEL3	Antenna cable 4,0 m (13.2 ft) TNC → BNC, RG-142, 1,72dB
TRKABEL4	Antenna cable 6,5 m (21.3 ft) TNC → BNC, RG-142, 2,8 dB
CI-105	Transponder/DME Antenna TSO C66b, C74c CI105 Comant Industries Inc. Height: 3,25", Weight: 90 g (0.2 lbs)
AV22	Rod antenna

3.12 Drawings

3.12.1 Dimensions

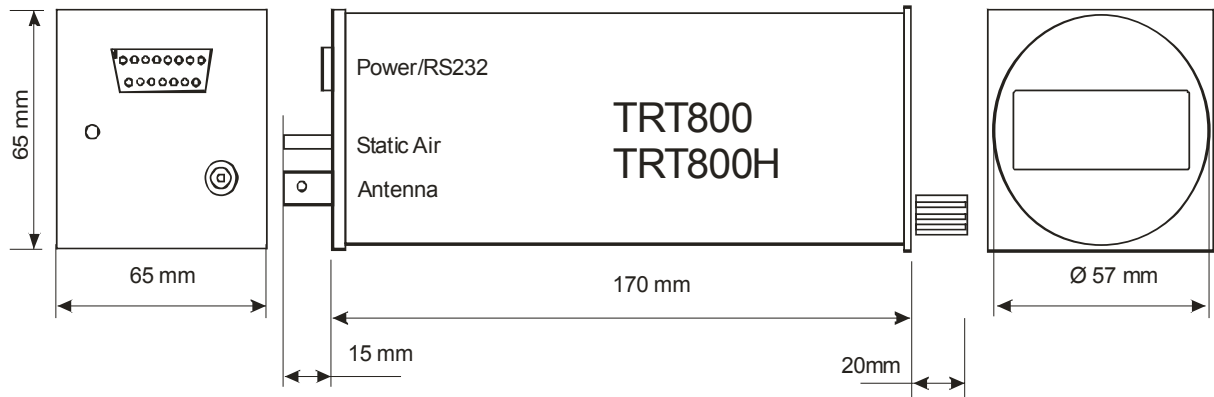

3.12.2 Mounting Advices

Connections Area

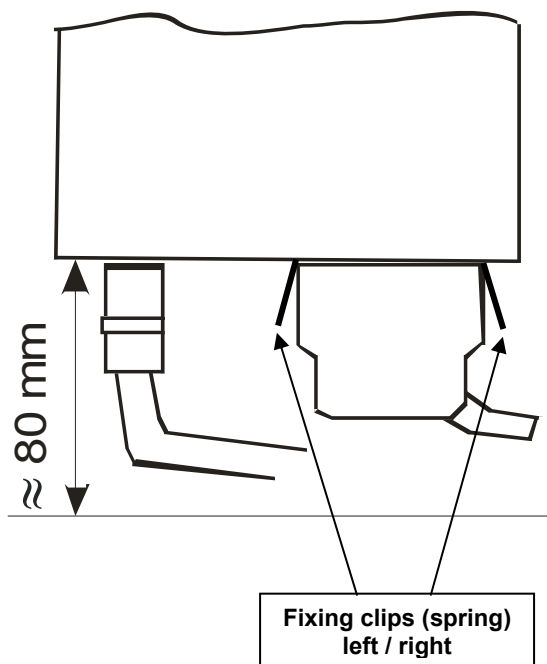

Panel Cut-out

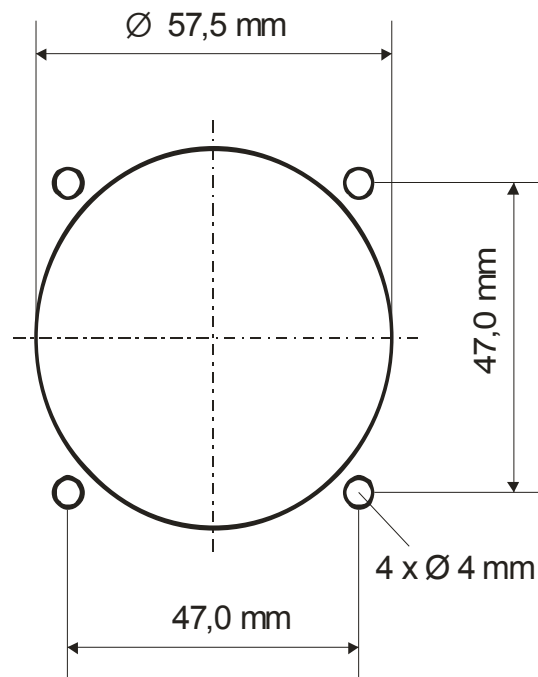

	<p>Connector (plug) has to be clamped with both spring locks</p>
--	--

4 SETTINGS

4.1 Overview

The TRT800H is capable of storing the following information:

- ICAO 24-Bit Aircraft-Address (AA), see section 4.2.1
- Aircraft Category (AC), see section 4.1.3, e.g.
 - „19“ for gliders
 - „21“ for aircrafts with a MTOW below 15.500 lbs, motor glider
 - „1C“ for ultra light aircraft
- Flight Identification (FID), e.g. „DEOLK“, see section 4.1.4 (Important: Enter FID without any blanks and dashes!)
- Ground-Switch (Yes/No), see section 4.1.5
- Speed Category (RI), see section 4.1.6
- RS232 Interface Configuration, e. g. for connecting a GPS-Receiver to support ADS-B Out

All of these data are configurable in the Setup (refer to section 4.2.1) and are stored in the external memory module integrated within the housing of the D-Sub connector (included in the delivery).

The cable with this connector shall remain in the aircraft even if the unit is removed, to ensure that the ICAO 24bit aircraft address is fixed to the aircraft.

4.1.1 Error Logging

If errors occur, those will be internally stored in the order of appearance.

The error list can be displayed as described in chapter 4.2.2 Functions Overview.

4.1.2 ICAO 24-Bit Aircraft Address (AA)

Ask your national aviation authority (e. g. in Germany: LBA, Referat B5, Department “Verkehrszulassung”) how to obtain the AA. In the case of aerial sports equipment the contact point would be the respective associations.

Only the assigned AA has to be used and must not be modified at any time, because a duplicate address would jeopardize the data surveillance and integrity figures of Mode S.

	<p>If no AA is stored, after power on the display shows "CRADLE OFF" and the transponder operates in Mode A/C. (Configuration of the AA: see section 4.2.1)</p>
---	---

4.1.3 Aircraft Category (AC)

Code	Description	Code	Description
11	Emergency Vehicle	1C	Ultra-Light / Paraglider
12	Service Vehicle	1E	Drone
19	Glider	21	Aircraft (D-Exxx) < 15.500 lbs, Motor Glider (D-Kxxx)
1A	Balloon & Airship	22	Aircraft ≥ 15.500 lbs, < 75.000 lbs
1B	Paratrooper	27	Rotorcraft

	<p>Only one of the Codes mentioned in the table above must be used.</p>
---	---

4.1.4 Flight-ID (FID)

Per ICAO regulation Mode-S data must contain a valid flight identification (FID), to ensure that the correlation between flight plan and radar data will work automatically.

FID setting is required to correspond to the aircraft identification that has been (correctly!) specified at item 7 of the ICAO flight plan. It contains seven characters at a maximum (left-aligned, no additional zeros, dashes or spaces/blanks.)

For an aircraft using a company call sign, the Flight-ID mostly consists of the ICAO three-letter designator for the aircraft operator, followed by an identification code, e.g. KLM511, BAW213, JTR25.

If no company call sign is used or no flight plan is filed, the default FID to be set consists of the registration marking of the aircraft (e.g. DEABC) with no dashes, spaces/blanks or additional zeros, even if they are included in the registration marking on the aircraft (tail number). While entering the FID into the transponder the last remaining digits must be filled with blanks.



The ICAO Flight Plan only specifies 7 characters for FID. Funkwerk Avionics reserves 8 characters as stated in ED-73B for further expansion of the flight plan.

The user shall only program 7 characters for FID.

4.1.5 Option Ground-Switch

If a ground switch is connected (and declared in the configuration!), the transponder is able to acknowledge on-ground and in-flight state. In on-ground state, stand-by mode is activated.

With a connected ground switch (see section 3.6.1.2) the transponder automatically changes into Standby mode once the gear touched the ground. For this the Setup must be configured accordingly. For a detailed description of the Setup progress, please refer to 4.2.1 Setup Steps.

4.1.6 Reply Information - Speed Category (RI)

Besides AA, AC and FID another important part of the Mode-S data is the Speed Category of the respective aircraft. This speed category shall be configured in the setup (see 4.2.1) and must contain one of the following codes.

Code	Description
08	No maximum airspeed data available.
09	Maximum airspeed \leq 75 kt
10	75 kt > maximum airspeed \leq 150 kt
11	150 kt > maximum airspeed \leq 300 kt
12	300 kt > maximum airspeed \leq 600 kt
13	600 kt > maximum airspeed \leq 1200 kt
14	Maximum airspeed > 1200 kt
15	Not assigned

4.1.7 Serial Interface (RS232)

With the additionally available address adaptor TRT800EMSS the RS232 interface can be connected to a GPS receiver, to support the ADS-B Out functionality (Broadcasting of own position which could be received by other appropriately equipped aircrafts and processed for collision avoidance).

Selectable Options (*How to proceed, see 4.2 Configuration*):

- GPS-Receiver for ADS-B out
 - FREEFLIGHT (GPS / WAAS Sensor 1201, 19200 Bd)
 - setting of the GPS receiver: not required.
 - NexNav NNL 3101
 - setting of the GPS receiver: not required
 - KLN94 (Bendix King, KLN 89B, KLN 94, KMD 150, 9600 Bd)
 - setting of KLN89B/KLN94: “Standard RS232 Sentence”
 - setting of KMD 150: “Type 1 Sentence”
 - NMEA-Format (4800 Bd)
 - setting: data format RMC is expected; to minimize the amount of data other sub-formats are to be avoided.

- Comm-A/B-support (38400 Bd)

Data format for special purpose. An additional data link processor allows COMM-A/B operation and processing of the position information of a flight management system simultaneously.

Available since software version V5.2

- FAVISIA-support
 - FAVISIA
Data format to be processed in FAVISIA avionics suite.
 - FAVISIA + GPS
Data format to be processed in FAVISIA avionics suite (output) and additional processing of incoming GPS-Receiver position data (NMEA, 4800Bd) to support the ADS-B Out functionality



Setting for all described GPS-systems:

1 ... 2 messages per 2 sec.

Information regarding Comm-A/B support as to usability of other GPS equipment are available from Funkwerk Avionics GmbH.

4.2 Configuration

	<p>Programming of the ICAOA 24-bit Aircraft Address and of the Aircraft Category shall be executed by <u>qualified personnel</u> only!</p> <p>A wrong Aircraft Address or Flight ID may cause serious problems ATC or with ACAS/TCAS systems!</p> <p><u>Pilot and owner</u> are responsible for correctly set transponder data.</p>
---	---

4.2.1 Setup Steps





Initially after installation





The entered ICAO 24-bit address is stored in one out of eight possible records (Record=Presetting). Beside the 24bit address and the FID one record stores also the settings made for the serial interface (GPS/COMM A/B) and also for the optionally installed Ground-Switch. A stringently required input is the speed category (RI) of the respective aircraft (see section 4.1.6 “Reply Information - Speed Category (RI)”).

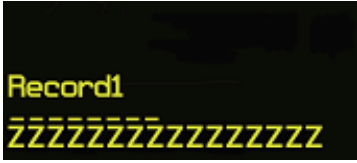
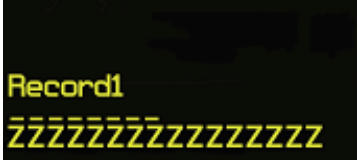

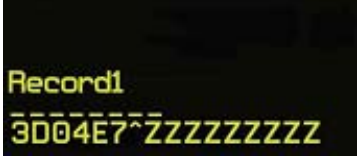
	<p>Any menu item can be passed by MODE. If no changes are made the original settings will remain stored. Modification of one menu item does not impact the others. No entries will be deleted.</p>
---	---

All those data are stored in one record. If more than one record exists, a record can be selected out of a list during start-up of the transponder.

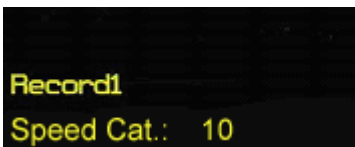
Step	Display (Example)
1. Start-up Transponder	

Step	Display (Example)
2. Ensure, the transponder-mode is „STBY“. If necessary change the mode by pressing MODE	
3. Press ID A counter is shown at the upper-right corner	
4. Hold ID the counter has reached „47“	
5. Release ID You have now entered the configuration mode for the ICAO 24-bit address.	
6. Initially the Cursor „^“ is located at the first digit in the lower line. The first six digits define the ICAO 24-Bit Aircraft Address. In order to enter your 24bit address, select the respective letter or number by usage of the rotary knob. ▶ moves the cursor rightwards. ◀▶ moves the cursor leftwards. It is important to enter the ICAO 24-Bit Aircraft Address correctly.	 
7. With digits 7 and 8 the Aircraft Category is specified. (see section 4.1.3)	

Step	Display (Example)
<p>8. With digit 9 and the following the Flight-ID is defined (e. g. DEOLK)</p> <p>Important: Without blanks or any special characters and also <u>without</u> dashes.</p>	
<p>9. The last digits of the line must be filled with blanks.</p>	
<p>10. Press MODE.</p> <p><i>with the rotary knob you can now select „yes“ if a Ground Switch is installed, if not select “no” and proceed with step 11</i></p>	
<p>11. Press MODE.</p> <p>at this stage the respective speed category <u>shall</u> be selected by using the rotary knob. (see section 4.1.6)</p>	
<p>12. Press MODE.</p> <p><i>at this stage a GPS receiver for ADS-B Out can be selected (Selectable by rotary knob).</i></p>	
<p>13. Press MODE.</p> <p><i>with ID further Records can now be created and configured as described in the aforementioned steps</i></p> <p><i>at start-up of the transponder one of the defined records with all associated configurations need to be selected</i></p>	

Step	Display (Example)
14. Press MODE . You have now left the configuration mode and are back in normal operation.	
15. Switch Off the transponder	
16. Switch On the transponder. Your ICAO 24-Bit Aircraft Address is now stored.	

4.2.2 Functions Overview

In order to access the functions described in the following table press **ID** during Standby mode and release **ID** at the corresponding counter value. Proceed analogue to the steps 1 to 4 described in the table in section 4.2.1.













The lower line contains the ICAO 24-Bit Aircraft Address (AA), the Aircraft-Category (AC) und die Flight-ID (FID). AA and AC are marked by a line above the numbers:

Digits 1 ... 6: ICAO 24-Bit Aircraft Address (HEX-Format)

Digits 7 ... 8: Aircraft Category

Digits 9 ... 16: Flight-ID (FID)

Counter	Function
1..4	Just <u>Display</u> of: ICAO 24-Bit Aircraft Address (AA) Aircraft-ID (AC) Flight-ID (FID) Display-Mode automatically switches back to STBY
5..19	Change only FID (AA/AC-input locked) <ul style="list-style-type: none"> • Set Cursor („^“) with  • turn rotary knob to select characters • press MODE to save and to return to STBY

Counter	Function
20	Test-Mode <ul style="list-style-type: none"> • leave the test mode with 
40	display error logging press  to return to STBY
47	enter ICAO-24bit Aircraft Address / Aircraft Category (AC) / Flight-ID (FID) <ul style="list-style-type: none"> • the  button shifts the Cursor („^“) one digit to the right, the  button shifts it one digit to the left • turn rotary knob to select characters • press  to enter the next menu item <i>changes are kept in memory, but are not yet active</i> • press  to return to the previous menu item <hr/> Ground-Switch-Info <ul style="list-style-type: none"> • turn rotary knob to select option (Yes/No) • press  to enter the next menu item <i>changes are kept in memory, but are not yet active</i> • press  to return to the previous menu item <hr/> Speed Category <ul style="list-style-type: none"> • with respect to the maximum airspeed of the aircraft enter the corresponding value (see section 4.1.6) with the rotary knob • press  to enter the next menu item <i>changes are kept in memory, but are not yet active</i> • press  to return to the previous menu item <hr/> configure RS232 interface (refer to section 4.1.7) <ul style="list-style-type: none"> • turn rotary knob to select option • press  to save and to return to STBY • Transmission of position data is indicated by “p” (type of squitter) in the upper line in the test mode <hr/> Turn power off and on again with  to activate new settings.

5 APPENDIX

5.1 Technical Data

Compliance	CS-ETSO-2C112a EASA.210.269
Applicable Documents	CS-ETSO-2C112a EUROCAE ED-73B Class 1 Level 2es EUROCAE ED-26 RTCA DO-160D RTCA DO-178B Software-Level D
Temperature Ranges Operation Storage	-20 °C to +55 °C; for 30 min +70°C -55 °C to +85 °C
Altitude Range	≤ 35 000 ft
Speed Range	≤ 250 kt (TAS)
Shock	6 G Operation 20 G crash safety
Environmental Categories	RTCA DO-160D Env.Cat.: [C1Z]CAA[SM]XXXXXXZBAAA[TT]M[B3F3] XXA
Power Supply	13,8 VDC (10 VDC .. 16 VDC) 0,40 A @ 13,8 VDC (typ.) 0,70 A @ 13,8 VDC (max.) 10 W (max)
Fuse	External 2A-slow-blow fuse
Mounting	Panel cut-out d=57,5 mm

Weight	0,6 kg (1.32 lbs.)
Receiver Characteristics: Sensitivity	RF input power level resulting in a 90 % reply rate: A. MTL for ATCRBS and ATCRBS/Mode S All-Call interrogations: -74 dBm \pm 3 dB. B. MTL for Mode S interrogations: -74 dBm \pm 3 dB.
Reply transmission frequency	1090 \pm 1 MHz
RF Peak Power Output	\geq 21 dBW (126 W) at antenna base (with maximum cable attenuation of 1,5 dB)
Squitter (ADS-B)	transmitted at random intervals uniformly distributed over the range from 0.8 to 1.2 seconds, full self-verification of data and occurrence
Mode S Elementary Surveillance	
ICAO 24-bit Aircraft Address (Hex-Code)	aircraft address as assigned by national aviation authority
FID	Flight ID: Flight Plan call sign or aircraft registration marking
Capability Report	Reports the available data and means by which the transponder can report.
Pressure Altitude	Up to 35 000 ft in 25 ft increments
Flight Status	in-flight / on-ground
Mode S Enhanced Surveillance	
Level 2es	Comm-A / Comm-B: 56/112-Bit-Messages SI-capability

5.2 Environmental Conditions

Characteristic DO-160D	Section	Cat.	Condition
Temperature / Altitude	4.0		
Low ground survival temperature	4.5.1	C1	- 55°C
Low operating temperature	4.5.1		- 20°C
High ground survival Temperature	4.5.2		+ 85°C
High Short-time Operating Temperature	4.5.2		+ 70°C
High Operating Temperature	4.5.3		+ 55°C
In-Flight Loss of Cooling	4.5.4	Z	No auxiliary cooling required
Altitude	4.6.1	C1	35 000 ft
Temperature Variation	5.0	C	2°C change rate minimum per minute
Humidity	6.0	A	
Shock	7.0	A	6 G operational shocks 20 G Crash Safety Test Type R in all 6 directions
Vibration	8.0	S	Vibration Curve M
Explosion Proofness	9.0	X	No test required
Water Proofness	10.0	X	No test required
Fluids Susceptibilities	11.0	X	No test required
Sand and Dust	12.0	X	No test required
Fungus Resistance	13.0	X	No test required
Salt Spray	14.0	X	No test required
Magnetic Effect	15.0	Z	Less than 0,3 m
Power Input (DC)	16.0	B	
Voltage Spike Conducted	17.0	A	
Audio Frequency Conducted	18.0	A	

Characteristic DO-160D	Section	Cat.	Condition
Susceptibility			
Induced Signal Susceptibility	19.0	A	
Radio Frequency Susceptibility	20.0	TT	
Emission of RF Energy	21.0	M	
Lightning Induced Transient Susceptibility	22.0	B3F3	
Lightning Direct Effects	23.0	X	No test required
Icing	24.0	X	No test required
Electrostatic Discharge (ESD)	25.0	A	

Notes:

Funkwerk Avionics GmbH

Gewerbestraße 2
D-86875 Waal
Germany

phone.: +49-8246 9699 0

fax.: +49-8246 1049

E-mail:

service@funkwerk-avionics.com

www.funkwerk-avionics.com